

## Mod. 2611 - Fittings Serie 2000

Product code: 2611 3/8

Datasheet creation date: 20/05/2026 06:04

Check the most updated document online [click here](#)



### ■ TECHNICAL DATA

Mod.	2611 3/8
------	----------

## Mod. 2611 - Fittings Serie 2000

Product code: 2611 3/8

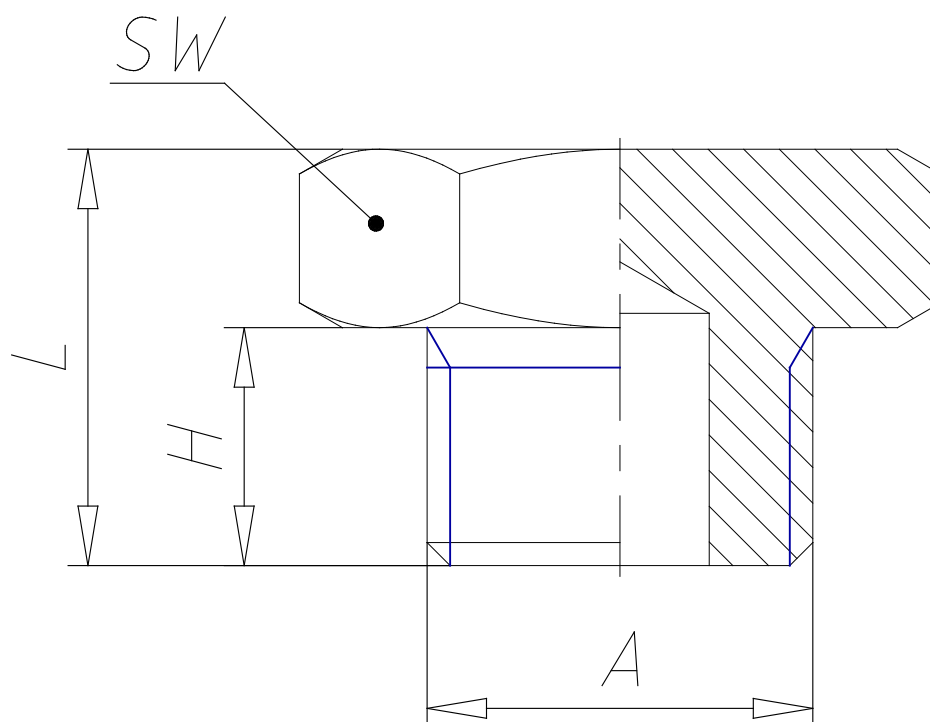

### DIMENSIONS

<b>A</b>	G3/8
<b>H (mm)</b>	9
<b>L (mm)</b>	14.0
<b>SW (mm)</b>	19