

Mod. 2521 - Fittings Serie 2000

Product code: 2521 3/8-3/8

Datasheet creation date: 19/05/2026 18:01

Check the most updated document online [click here](#)



■ TECHNICAL DATA

Mod.	2521 3/8-3/8
------	--------------

Mod. 2521 - Fittings Serie 2000

Product code: 2521 3/8-3/8

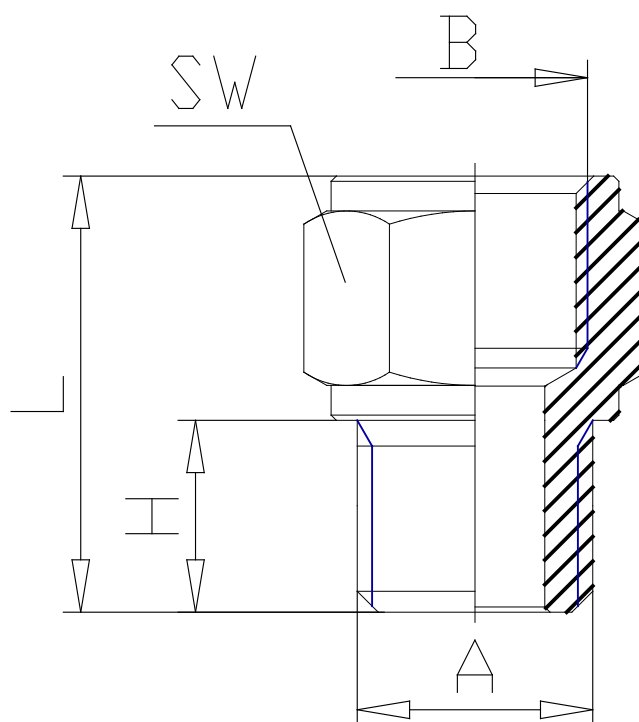

DIMENSIONS

A	G3/8
B	G3/8
H (mm)	9
L (mm)	21.5
SW (mm)	20