

Mod. 2521 - Fittings Serie 2000

Product code: 2521 1/8-1/4

Datasheet creation date: 19/05/2026 08:53

Check the most updated document online [click here](#)



■ TECHNICAL DATA

Mod.	2521 1/8-1/4
------	--------------

Mod. 2521 - Fittings Serie 2000

Product code: 2521 1/8-1/4

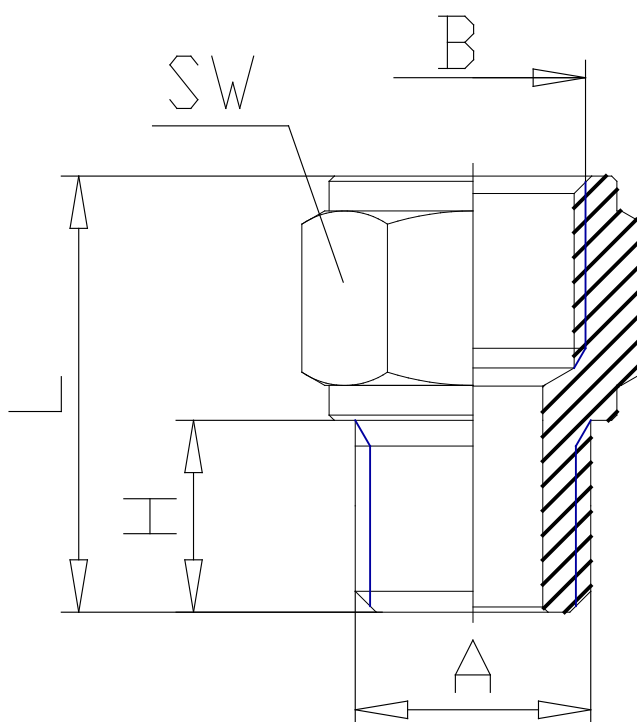

DIMENSIONS

A	G1/8
B	G1/4
H (mm)	6
L (mm)	17.5
SW (mm)	17