

Mechanically operated minivalves - Series 2 / 234-955

Product code: 234-955

Datasheet creation date: 19/05/2026 08:50

Check the most updated document online [click here](#)

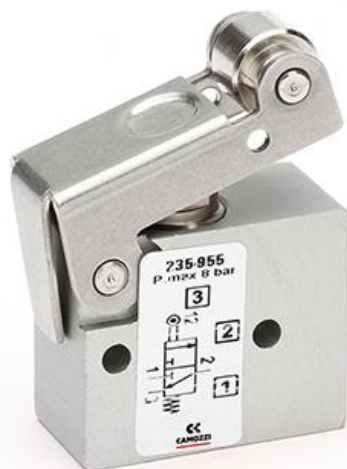

TECHNICAL DATA

Mod.	234-955
Operating pressure (bar)	2 ÷ 10
Flow rate NI/min	60NL/min
Actuating force	a 6 bar =6N
Thread port (mm)	Ø4
Activity	Actuating lever / roller

Mechanically operated minivalves - Series 2 / 234-955

Product code: 234-955

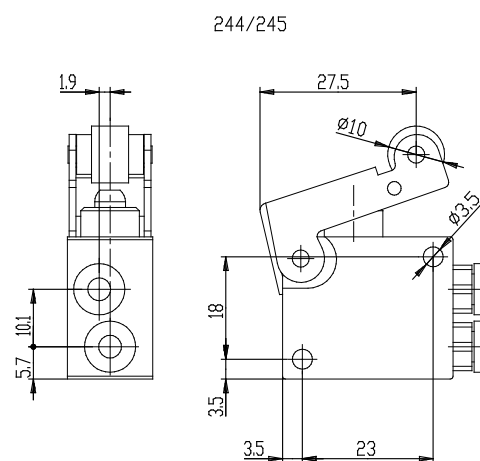
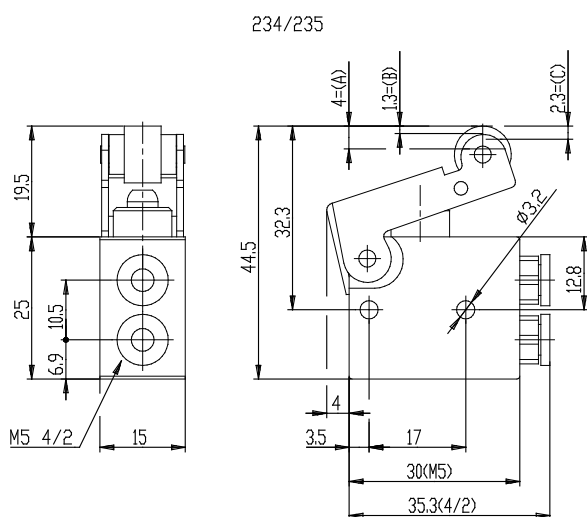

DIMENSIONS

Mod.	234-955
Operating pressure (bar)	2 ÷ 10
Flow rate NI/min	60NL/min
Actuating force	a 6 bar =6N
Thread port (mm)	Ø4
Activity	Actuating lever / roller