

- Fittings Mod. 1635 01

Product code: 1635 01-1/4

Datasheet creation date: 19/05/2026 08:52

Check the most updated document online [click here](#)



TECHNICAL DATA

Mod.	1635 01-1/4
------	-------------

- Fittings Mod. 1635 01

Product code: 1635 01-1/4

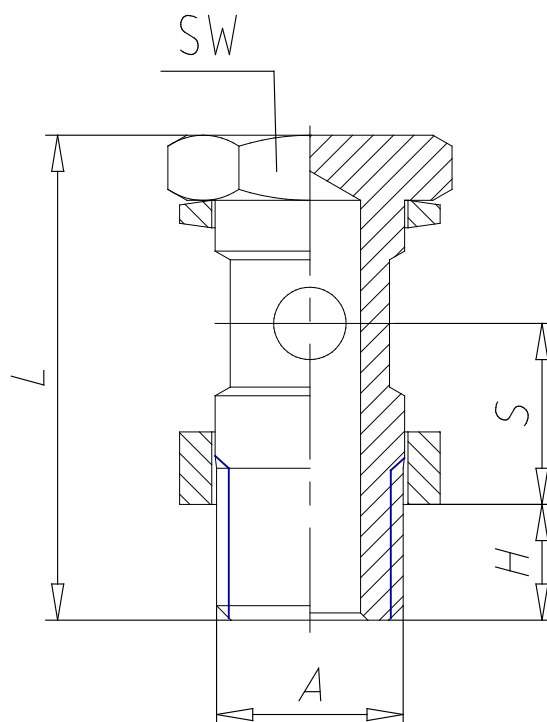

■ DIMENSIONS

A	G1/4
H (mm)	8
L (mm)	33.5
heavy (mm)	12.5
SW (mm)	17
Assembly	