

- Fittings Mod. 1620

Product code: 1620 8/6-1/4

Datasheet creation date: 19/05/2026 17:59

Check the most updated document online [click here](#)



■ TECHNICAL DATA

Mod.	1620 8/6-1/4
------	--------------

- Fittings Mod. 1620

Product code: 1620 8/6-1/4

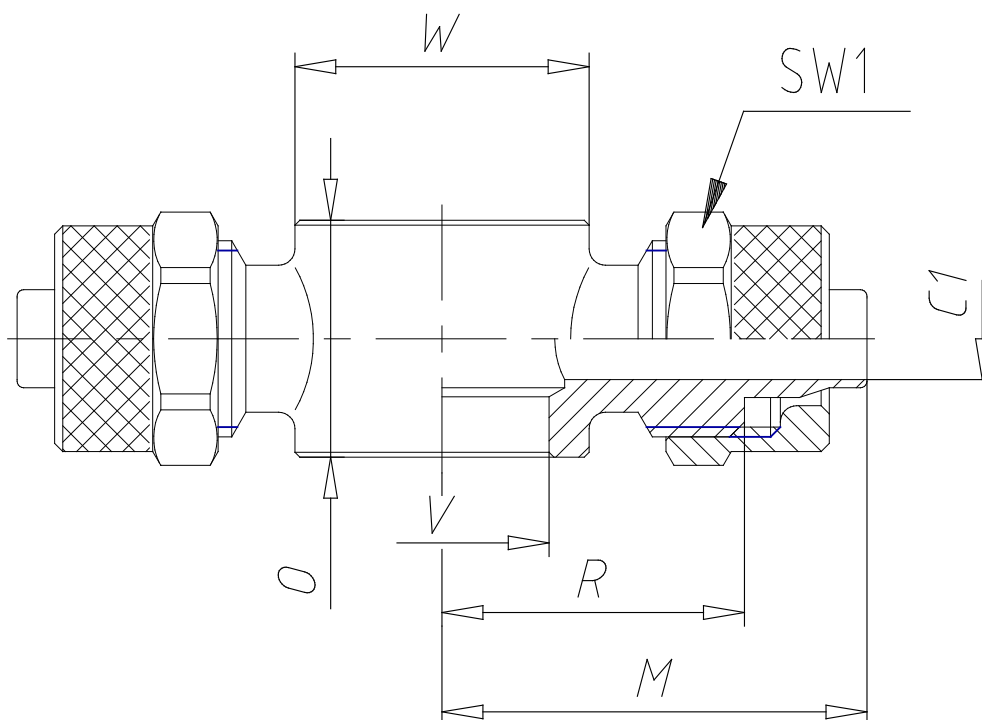

DIMENSIONS

Tube	8/6
C1 (mm)	5
M (mm)	26
O (mm)	14.5
R (mm)	18.5
V (mm)	13.2
W	Ø18
SW1 (mm)	14