

- Fittings Mod. 1560

Product code: 1560 10/8-1/4

Datasheet creation date: 19/05/2026 17:59

Check the most updated document online [click here](#)



■ TECHNICAL DATA

Mod.	1560 10/8-1/4
------	---------------

- Fittings Mod. 1560

Product code: 1560 10/8-1/4

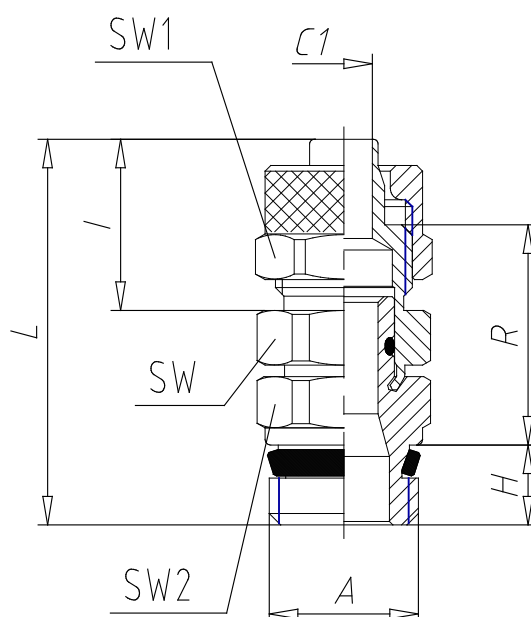

■ DIMENSIONS

Tube	10/8
A	G 1/4
C1 (mm)	6.5
H (mm)	7.0
I (mm)	16.5
L (mm)	34.5
R (mm)	19.0
SW (mm)	14
SW1 (mm)	16
SW2 (mm)	14