

Compact minicylinder - Series 14

Product code: 14N1M16B10

Datasheet creation date: 19/05/2026 08:34

Check the most updated document online [click here](#)



TECHNICAL DATA

Series	14
Version	N = non magnetic
Operation	1 = single acting
Connection type	M = M5 thread
Diameter (mm)	16
Construction	B = threaded rod
Stroke (mm)	10

Compact minicylinder - Series 14

Product code: 14N1M16B10

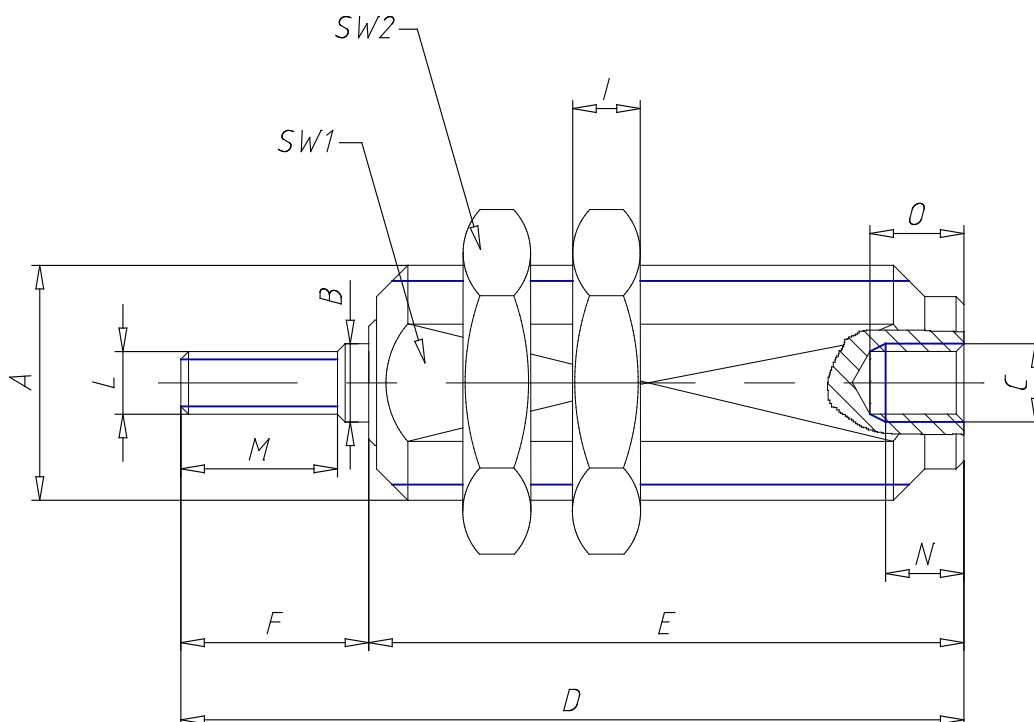

DIMENSIONS

A	M22x1,5
Ø B (mm)	6
C (mm)	4/2
D (mm)	55.5
E (mm)	41.5
F (mm)	14
SW1 (mm)	20
SW2 (mm)	27
I (mm)	5
L	M5
M (mm)	12
N (mm)	5
O (mm)	6