

Compact minicylinder - Series 14

Product code: 14N1M10B05

Datasheet creation date: 19/05/2026 08:56

Check the most updated document online [click here](#)



TECHNICAL DATA

Series	14
Version	N = non magnetic
Operation	1 = single acting
Connection type	M = M5 thread
Diameter (mm)	10
Construction	B = threaded rod
Stroke (mm)	5

Compact minicylinder - Series 14

Product code: 14N1M10B05

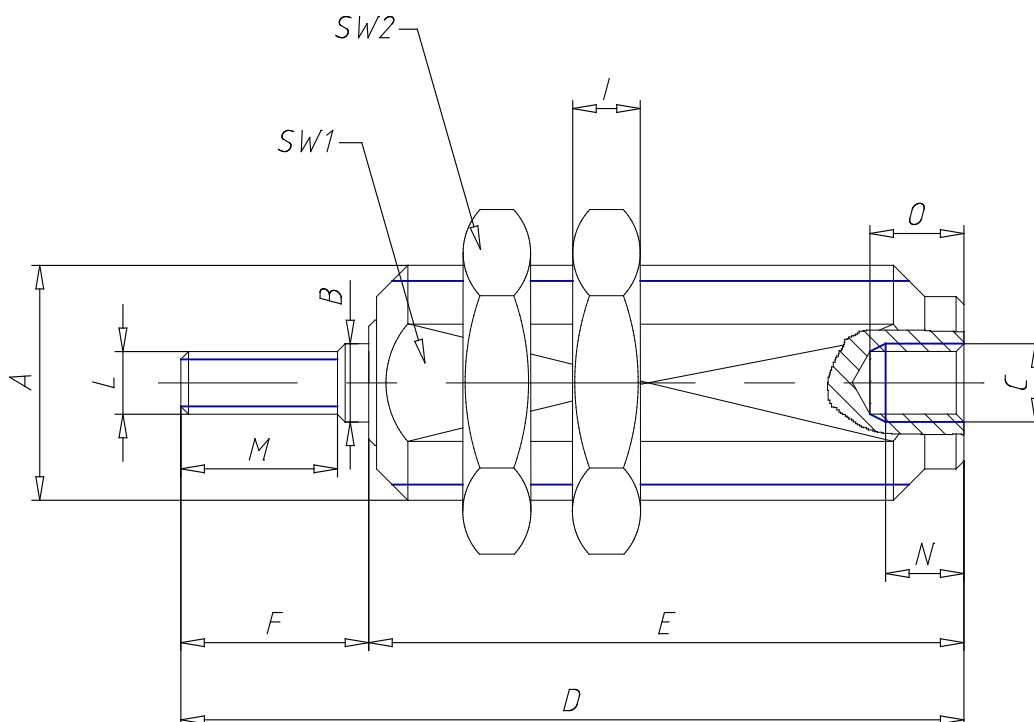

DIMENSIONS

A	M15x1,5
Ø B (mm)	5
C (mm)	4/2
D (mm)	43.0
E (mm)	31.0
F (mm)	12
SW1 (mm)	13
SW2 (mm)	19
I (mm)	4
L	M4
M (mm)	10
N (mm)	5
O (mm)	6