

## Compact minicylinder - Series 14

Product code: 14N1M06A15

Datasheet creation date: 19/05/2026 08:56

Check the most updated document online [click here](#)



### TECHNICAL DATA

<b>Series</b>	14
<b>Version</b>	N = non magnetic
<b>Operation</b>	1 = single acting
<b>Connection type</b>	M = M5 thread
<b>Diameter (mm)</b>	6
<b>Construction</b>	A = non-threaded smooth piston rod
<b>Stroke (mm)</b>	15

## Compact minicylinder - Series 14

Product code: 14N1M06A15

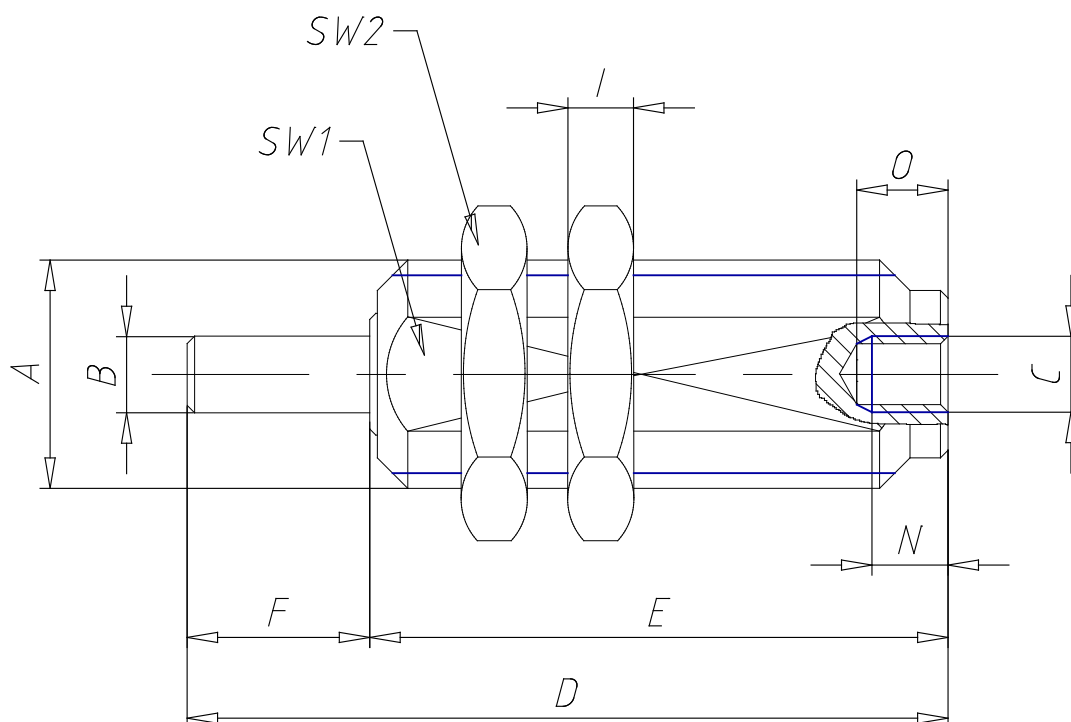

### DIMENSIONS

<b>A</b>	M10x1
<b>Ø B (mm)</b>	3
<b>C (mm)</b>	4/2
<b>D (mm)</b>	41.0
<b>E (mm)</b>	36.0
<b>F (mm)</b>	5
<b>SW1 (mm)</b>	9
<b>SW2 (mm)</b>	12
<b>I (mm)</b>	3
<b>L</b>	-
<b>M (mm)</b>	7
<b>N (mm)</b>	5
<b>O (mm)</b>	6