

Mechanically operated valves - Series 1 and 3 / 138-965

Product code: 138-965

Datasheet creation date: 19/05/2026 17:08

Check the most updated document online [click here](#)



TECHNICAL DATA

Mod.	138-965
Operating pressure (bar)	0÷10 bar
Flow rate	500NL/min
Actuating force	41N
Activity	Actuating unidirectional lever / roller

Mechanically operated valves - Series 1 and 3 / 138-965

Product code: 138-965

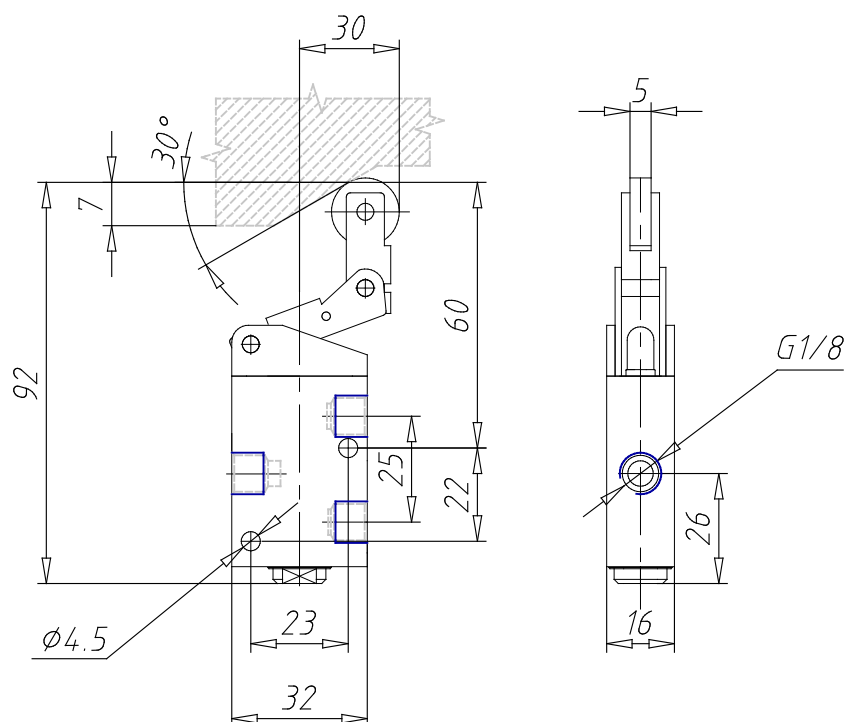

DIMENSIONS

Mod.	138-965
Operating pressure (bar)	0÷10 bar
Flow rate	500NL/min
Actuating force	41N
Activity	Actuating unidirectional lever / roller