

Mechanically operated valves - Series 1 and 3 / 134-955

Product code: 134-955

Datasheet creation date: 19/05/2026 08:50

Check the most updated document online [click here](#)



TECHNICAL DATA

Mod.	134-955
Operating pressure (bar)	0÷10 bar
Flow rate	1250NL/min
Actuating force	41N
Activity	Actuating lever / roller

Mechanically operated valves - Series 1 and 3 / 134-955

Product code: 134-955

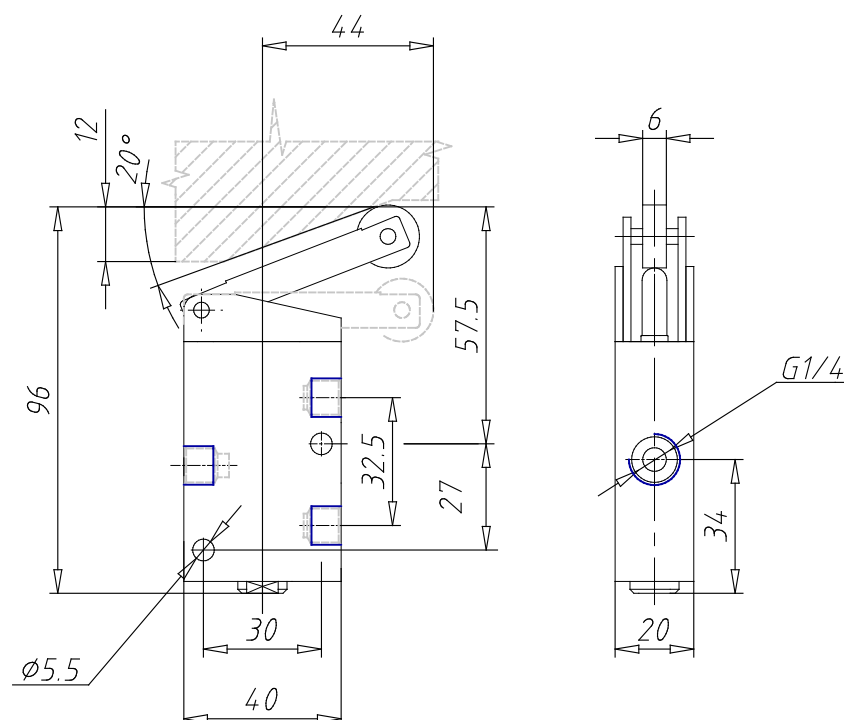

DIMENSIONS

Mod.	134-955
Operating pressure (bar)	0÷10 bar
Flow rate	1250NL/min
Actuating force	41N
Activity	Actuating lever / roller