



Serie **2 vie**

Articolo **8P003200 - 8P003400**

2 way "WAFER" ball valve [Valpres Art. 721000 AISI 316], flanged, stainless steel AISI 316, with actuator.

PRESSIONE MINIMA ALIMENTAZIONE ATTUATORE 6 bar actuator air supply pressure minimum 6 bar

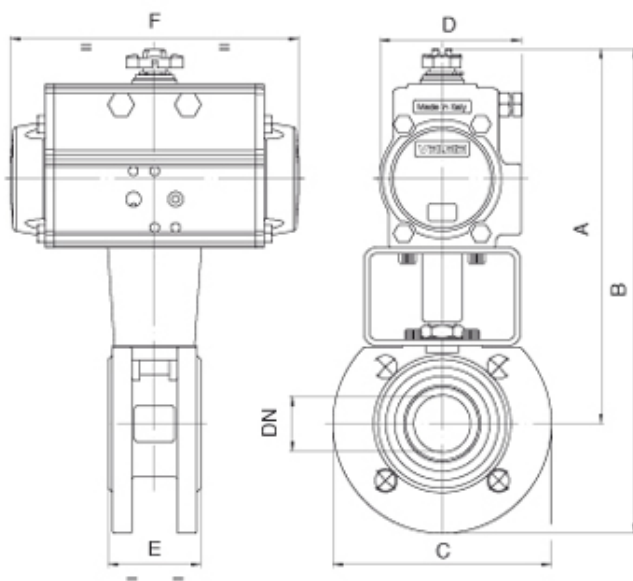

Art. 8P003200

VALVOLA CON ATTUATORE DOPPIO EFFETTO VALVE WITH DOUBLE ACTING ACTUATOR

DN	15	20	25	32	40	50	65	80	100	125	150	200
PN	16	16	16	16	16	16	16	16	16	16	16	16
A	147	188	201	200	227	253	285	292	341	398	435	
B	192	238	259	270	302	336	378	392	451	523	577	
C	90	100	115	140	150	165	185	200	220	250	285	
D	45	71	71	71	81	95	106	106	123	137	148	
E	35	40	46	54	64	82	103	122	152	196	232	
F	110	141	141	141	164	210	241	241	275	333	372	
ACT.	DA 32	DA 52	DA 52	DA 52	DA 63	DA 75	DA 85	DA 85	DA 100	DA 115	DA 125	
RI	3012	3013	3001	3008	3002	3009	3003	3003	3004	3005	3006	

Art. 8P003400

VALVOLA CON ATTUATORE SEMPLICE EFFETTO VALVE WITH SPRING RETURN ACTUATOR

DN	15	20	25	32	40	50	65	80	100	125	150	200
PN	16	16	16	16	16	16	16	16	16	16	16	16
A	183	200	207	212	259	281	352	371	387	432	481	
B	228	250	265	287	334	363	445	471	497	557	624	
C	90	100	115	140	150	165	185	200	220	250	285	
D	71	81	81	81	106	123	137	148	148	164	187	
E	35	40	46	54	64	82	103	122	152	196	232	
F	141	164	164	164	241	275	333	372	372	435	500	
ACT.	SR 52	SR 63	SR 63	SR 63	SR 85	SR 100	SR 115	SR 125	SR 125	SR 140	SR 160	
RI	3780	3014	3007	3048	3009	3009	3010	3010	3005	3037	3039	

